

# Assembly Instruction

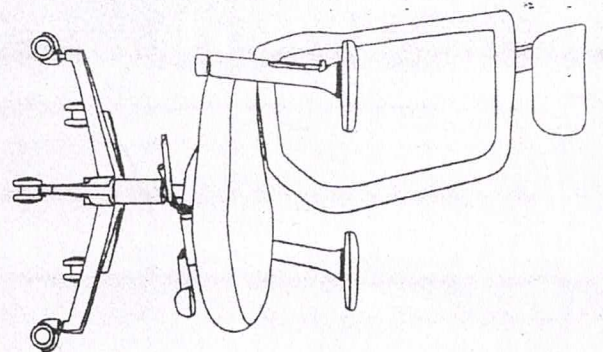
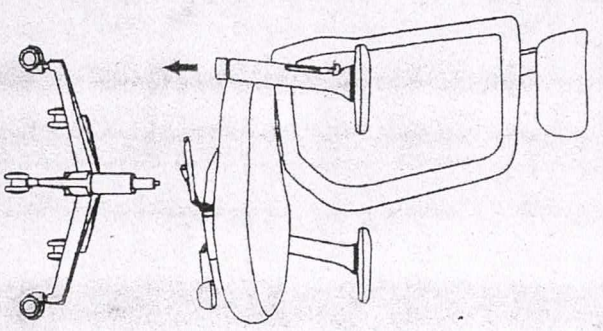
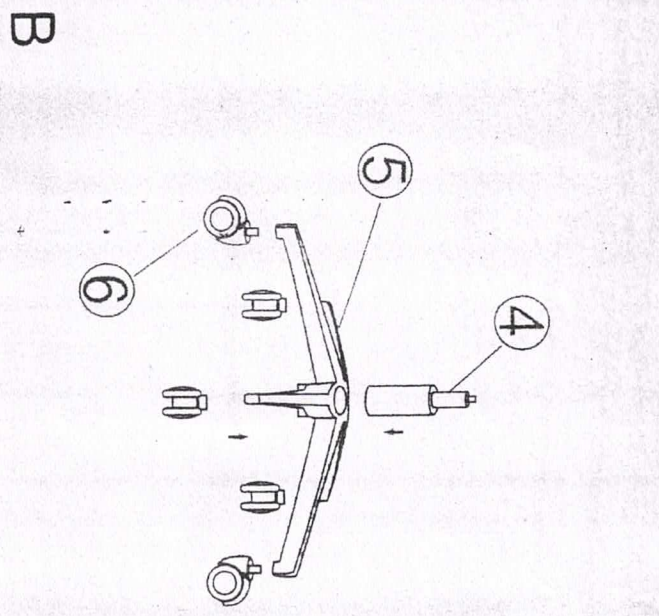
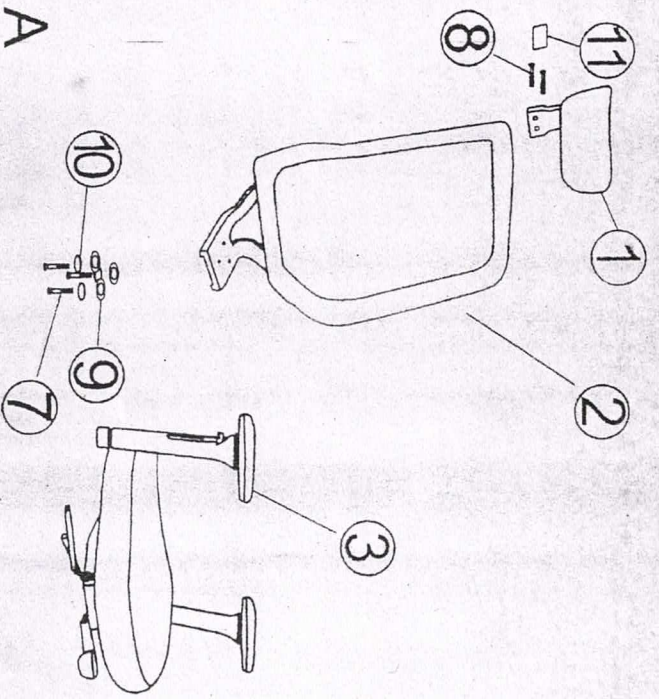

No.	Accessories	Size	QTY
①			1
②			1
③			1
④			1
⑤			1
⑥			5
⑦		8*20	3
⑧		6*16	2
⑨		M8	3
⑩		M8	3
⑪			1
Tool:		M6	1
Tool:		M8	1